

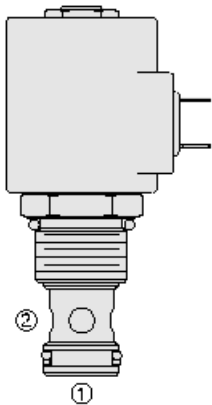

Overview



Description

A solenoid-operated, 2 way, normally closed, poppet-type, screw-in hydraulic cartridge valve, designed to function as a load holding or blocking valve in applications requiring low internal leakage.

Operation

When de-energized, the SV12-20X acts as a check valve, allowing flow to pass from port 1 to port 2, while blocking flow in the reverse direction. When energized, the poppet lifts to the port 2 to port 1 flow path. In this mode, flow from 1 to 2 is severely restricted.

Features

- Continuous-duty rated coil.
- Hardened seat for long life and low leakage.
- Optional coil voltages and terminations.
- Efficient wet-armature construction.
- Cartridges are voltage interchangeable.
- Unitized, molded coil design.
- Manual override option.
- Optional waterproof E-Coils rated up to IP69K.
- Cost-effective cavity.

Symbol

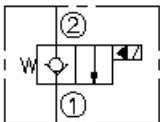

Ratings

Pressure Ratings

Pressure rating	240 bar (3500 psi)
Proof pressure	345 bar (5000 psi)
Burst pressure	827 bar (12000 psi)

Flow Ratings

Flow rating	See performance chart
Maximum internal leakage	3 drops/min - Note: Max at 240 bar (3500 psi)

Temperature Ratings

Operating fluid temperature	-40 to 100 °C (-40 to 212 °F)	- Note: With buna N seals
	-26 to 204 °C (-15 to 400 °F)	- Note: With fluorocarbon seals
	-54 to 107 °C (-65 to 225 °F)	- Note: With polyurethane seals
Storage temperature	-40 to 70 °C (-40 to 160 °F)	
Ambient temperature	-40 to 90 °C (-40 to 194 °F)	

Other Ratings

Corrosion protection	960 hr salt spray per ASTM b117 (gsv12-20x)
----------------------	---

Operating Parameters

Fluids	Mineral based or synthetic hydraulic fluid with lubricating properties
Fluid viscosity range	7.4 to 420 cSt
Maximum operating contamination level	18/16/13 per ISO 4406

Properties

Unit weight	0.25 kg (0.54 lb)	- Note: Blank
	0.26 kg (0.57 lb)	- Note: M j y
	0.67 kg (1.48 lb)	- Note: Including coil
Internal wetted surface area	155 cm ² (24.0 in ²)	- Note: Blank
	166 cm ² (25.7 in ²)	- Note: M j y



Performance

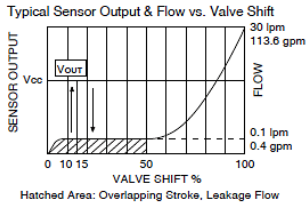
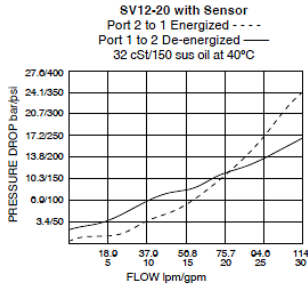
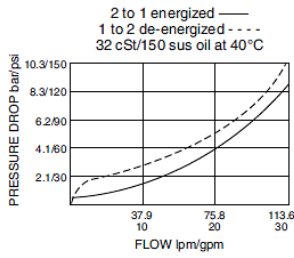

Dimensions

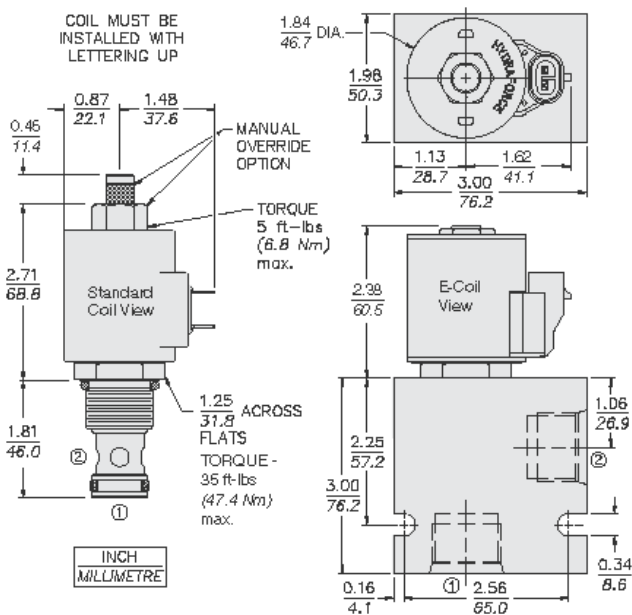

Installation Specifications

Cavity	VC12-2
Cartridge installation torque	44.8 to 50.2 N-m (33 to 37 ft-lb)
Maximum allowable torque	102 N-m (75 ft-lb)
Coil nut torque	6.8 to 9.5 N-m (5 to 7 ft-lb)
Orientation restriction	None

Accessories

Seal kit	SK12-2X-T	- Note: X = seal option
----------	-----------	-------------------------



Order Code

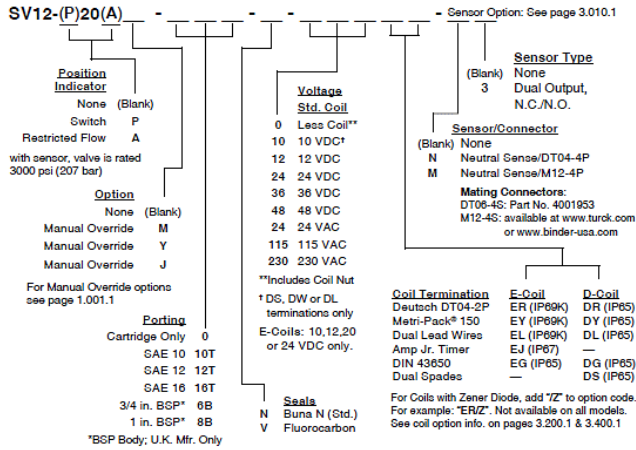

Model Options

SV12-A20AE-H-J-L-M

A Position Sensor Option

CODE	DESCRIPTION
20	Standard
P20A	Position Indicator Switch with Restricted Flow

E Manual Override

CODE	DESCRIPTION
BLANK	NONE
J	Momentary Pull Override, #10-32 threads
M	Two Position Override, Red Knurled Knob
Y	Momentary Pull Override, Red Knurled Knob

H Line Body

CODE	DESCRIPTION
0	No Body
10T	Aluminum SAE 10
12T	Aluminum SAE 12
16T	Aluminum SAE 16
12TD	Ductile Iron SAE 12
16TD	Ductile Iron SAE 16
8B	Aluminum BSPP 1" (8)
8BD	Ductile Iron BSPP 1" (8)

J Seal

CODE	DESCRIPTION
N	Buna-N
V	Fluorocarbon
P	Polyurethane
U	PPDI Urethane

L Coil

CODE	DESCRIPTION
0	No Coil



CODE	DESCRIPTION
10DG	10 VDC, D-Coil, DIN 43650
10DL	10 VDC, D-Coil, Dual Lead Wires
10DR/D	10 VDC, D-Coil, Deutsch with Diode
10DS	10 VDC, D-Coil, Dual Spade
10EL	10 VDC, E-Coil, Dual Lead Wires
10ER	10 VDC, E-Coil, Deutsch
10ER/Z	10 VDC, E-Coil, Deutsch with Zener Diode
12DG	12 VDC, D-Coil, DIN 43650
12DL	12 VDC, D-Coil, Dual Lead Wires, 18 inches long
12DL/36	12 VDC, D-Coil, Dual Lead Wires, 36 inches long
12DL/W	12 VDC, D-Coil, Dual Lead Wires with Weatherpak
12DL/W/D	12 VDC, D-Coil, Dual Lead Wires with Weatherpak with Diode
12DR	12 VDC, D-Coil, Deutsch
12DR/D	12 VDC, D-Coil, Deutsch with Diode
12DR/Z	12 VDC, D-Coil, Deutsch with Zener Diode
12DS	12 VDC, D-Coil, Dual Spade
12EG	12 VDC, E-Coil, DIN 43650
12EJ	12 VDC, E-Coil, AMP Jr.
12EL	12 VDC, E-Coil, Dual Lead Wires, 18 inches long
12EL/36	12 VDC, E-Coil, Dual Lead Wires, 36 inches long
12EL/W/Z	12 VDC, E-Coil, Dual Lead Wires with WeatherPak and Zener Diode
12EL/Z	12 VDC, E-Coil, Dual Lead Wires with Zener Diode
12ER	12 VDC, E-Coil, Deutsch
12ER/Z	12 VDC, E-Coil, Deutsch with Zener Diode
12EY	12 VDC, E-Coil, Metri-Pack 150
12EY/Z	12 VDC, E-Coil, Metri-Pack 150 with Zener Diode
20DR/D	20 VDC, D-Coil, Deutsch with Diode
20DS	20 VDC, D-Coil, Dual Spade
20ER	20 VDC, E-Coil, Deutsch
24AG	24 VDC, D-Coil, DIN 43650
24AP	24 VDC, D-Coil, 1/2" Conduit and Dual Lead Wires
24DG	24 VDC, D-Coil, DIN 43650
24DL	24 VDC, D-Coil, Dual Lead Wires
24DL/W	24 VDC, D-Coil, Dual Lead Wires with Weatherpak
24DL/W/D	24 VDC, D-Coil, Dual Lead Wires with Weatherpak with Diode
24DP	24 VDC, D-Coil, 1/2" Conduit and Dual Lead Wires
24DR	24 VDC, D-Coil, Deutsch
24DR/D	24 VDC, D-Coil, Deutsch with Diode
24DS	24 VDC, D-Coil, Dual Spade
24EG	24 VDC, E-Coil, DIN 43650
24EJ	24 VDC, E-Coil, AMP Jr.
24EL	24 VDC, E-Coil, Dual Lead Wires, 18 inches long
24EL/36	24 VDC, E-Coil, Dual Lead Wires, 36 inches long



CODE	DESCRIPTION
24EL/W/Z	24 VDC, E-Coil, Dual Lead Wires with WeatherPak and Zener Diode
24ER	24 VDC, E-Coil, Deutsch
24ER/Z	24 VDC, E-Coil, Deutsch with Zener Diode
24EY	24 VDC, E-Coil, Metri-Pack 150
24EY/Z	24 VDC, E-Coil, Metri-Pack 150 with Zener Diode
36DS	36 VDC, D-Coil, Dual Spade
115AG	115 VAC, D-Coil, DIN 43650
115AP	115 VAC, D-Coil, 1/2" Conduit and Dual Lead Wires
230AG	230 VAC, D-Coil, DIN 43650
230AP	230 VAC, D-Coil, 1/2" Conduit and Dual Lead Wires

M Position Sensor Termination

CODE	DESCRIPTION
BLANK	No Position Sensor
M3	Neutral Sense, M12-4P, Dual Output NC/NO
N3	Neutral Sense, DT04-4P, Dual Output NC/NO